

**Note: VDD\_PADS powers the internal PIO of the module**

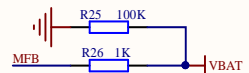

**Power on boot**

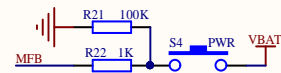

**Button boot**

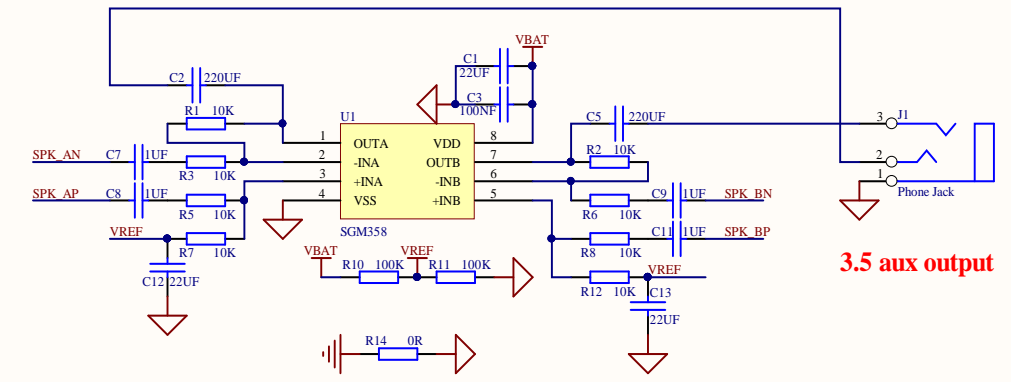

**Differential to single-ended analog audio output**

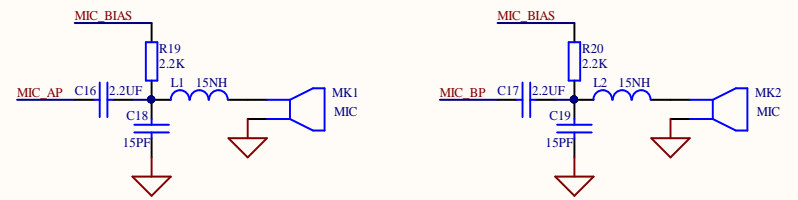

**microphone input**

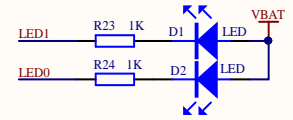

**LED : led0 red led1 blue**

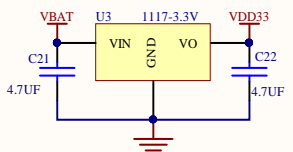

**VBAT voltage 3.3-4.2V**

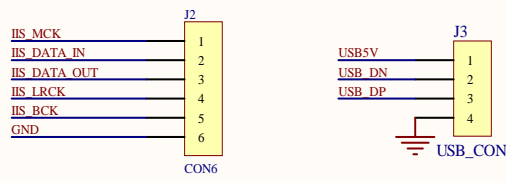

**I2S Digital audio output**

Title		
Size	Number	Revision
A4		
Date:	2021-11-21	Sheet of
File:	E:\Bluetooth\BTM544.Sch	Drawn By: