

Note: VDD_PADS powers the internal PIO of the module

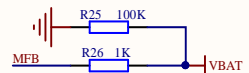

Power on boot

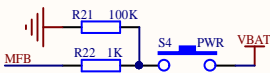

Button boot

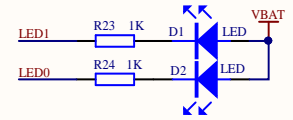

LED : led0 red led1 blue

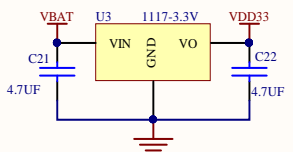

VBAT voltage 3.3-4.2V

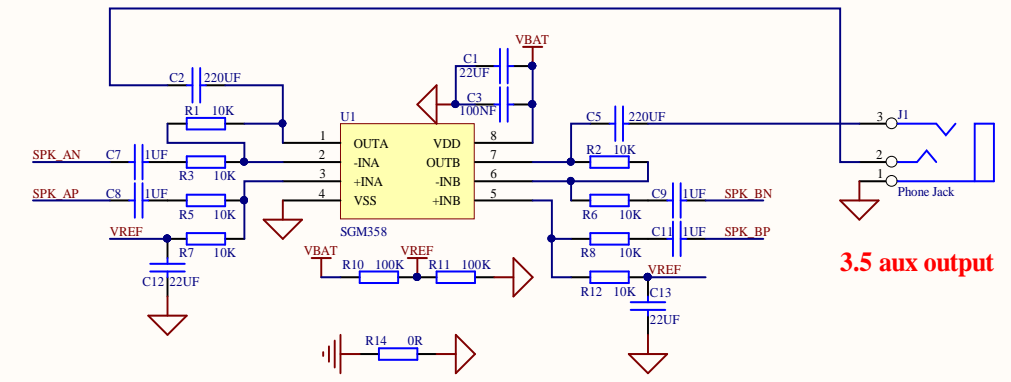

Differential to single-ended analog audio output

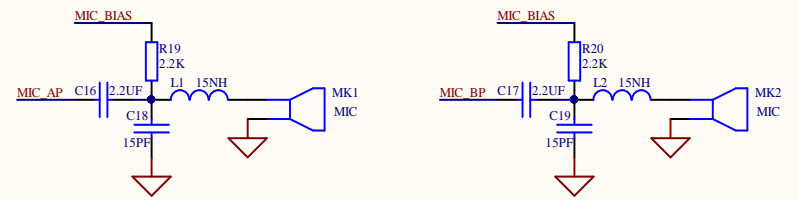

microphone input

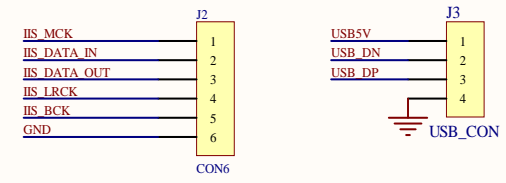

I2S Digital audio output

| | | |
|-------|-------------------------|-----------|
| Title | | |
| Size | Number | Revision |
| A4 | | |
| Date: | 2021-11-21 | Sheet of |
| File: | E:\Bluetooth\BTM331.Sch | Drawn By: |